



Wadia

a102 power amplifier

Owner's Manual





The lightning flash with arrowhead, within an equilateral triangle, is intended to alert the user to the presence of uninsulated “dangerous voltage” within the product’s enclosure that may be of sufficient magnitude to constitute a risk of electric shock to persons.

WARNING - TO REDUCE RISK OF FIRE OR ELECTRICAL SHOCK, DO NOT EXPOSE THIS EQUIPMENT TO RAIN OR MOISTURE.

IMPORTANT SAFETY INSTRUCTIONS!

PLEASE READ THEM BEFORE OPERATING THIS EQUIPMENT.

1. Read these instructions.
2. Keep these instructions.
3. Heed all warnings.
4. Follow all instructions.
5. Do not use this apparatus near water.
6. Clean only with a dry cloth.
7. Do not block any ventilation openings. Install in accordance with the manufacturer’s instructions.
8. Do not install near any heat sources such as radiators, heat registers, stoves, or other apparatus (including amplifiers) that produce heat.
9. Do not defeat the safety purpose of the polarized or grounding-type plug. A polarized plug has two blades with one wider than the other. A grounding type plug has two blades and a third grounding prong. The wide blade or the third prong are provided for your safety. If the provided plug does



AVIS RISQUE DE CHOC ELECTRIQUE - NE PAS OUVRIR.

NO USER-SERVICEABLE PARTS INSIDE. REFER SERVICING TO QUALIFIED PERSONNEL.

not fit into your outlet, consult an electrician for replacement of the obsolete outlet.

10. Protect the power cord from being walked on or pinched particularly at plugs, convenience receptacles, and the point where they exit from the apparatus.
11. Only use attachments/accessories specified by the manufacturer.
12. Use only with the cart, stand, tripod, bracket, or table specified by the manufacturer, or sold with the apparatus. When a cart is used, use caution when moving the cart/apparatus combination to avoid injury from tip-over.
13. Unplug this apparatus during lightning storms or when unused for long periods of time.
14. Refer all servicing to qualified service personnel. Servicing is required when the apparatus has been damaged in any way, such as power-supply cord or plug is damaged, liquid has been spilled or objects have fallen into the apparatus, the apparatus has been exposed to rain or moisture, does not operate normally, or has been dropped.
15. Do not expose this equipment to dripping or



The exclamation point within an equilateral triangle is intended to alert the user to the presence of important operating and maintenance (servicing) instructions in the literature accompanying the appliance.

To prevent the risk of electric shock, do not remove cover or back. No user-serviceable parts inside.

splashing and ensure that no objects filled with liquids, such as vases, are placed on the equipment.

16. To completely disconnect this equipment from the a.c. mains, disconnect the power supply cord plug from the a.c. receptacle.
17. The mains plug of the power supply cord shall remain readily operable.
18. Do not expose batteries to excessive heat such as sunshine, fire or the like.
19. Connect mains power supply cord only to a mains socket outlet with a protective earthing connection.

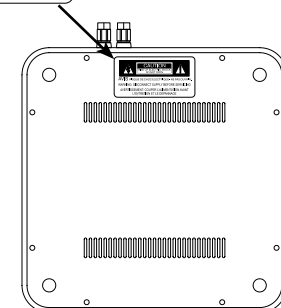

Bottom view of the Wadia a102

Thank You

All of us at Wadia Digital would like to say thank you, and congratulations for deciding to own this Wadia a102 power amplifier. We sincerely believe this Wadia product will bring you many years of musical enjoyment and satisfaction.

Please take a short time to read the information in this manual. We want you to be as familiar as possible with all the features and functions of your new Wadia Product.

About Wadia

Wadia Digital, founded in 1988, is one of the original companies dedicated to high performance digital audio reproduction. Wadia is based on the philosophy of applying advanced technology to improve the performance of digital audio components.

Wadia has consistently raised the standard for performance of Digital Audio playback. Some of the technological innovations pioneered by Wadia include:

- DigiMaster™ patented algorithm (filter optimized for reproducing music)
- ClockLink™ proprietary jitter reduction technology
- SwiftCurrent™ current to voltage conversion technology
- First outboard Digital-to-Analog converter
- First to apply glass fiber-optics to home audio

Our designs are born of a delicate balance of technology shaped by a passion for music. Wadia continues to re-define the limits of digital music playback.

Please Take A Moment

The serial number, purchase date and Wadia Dealer name are important to you for possible insurance claim or future service. The spaces below have been provided for you to record that information:

Serial Number: _____

Purchase Date: _____

Dealer Name: _____

Technical Assistance

If at any time you have questions about your Wadia product, contact your Wadia Dealer who is familiar with your Wadia equipment and any other brands that may be part of your system. If you or your Dealer wish additional help concerning a suspected problem, you can receive technical assistance for all Wadia products at:

Wadia Digital, LLC.
2 Chambers Street
Binghamton, New York 13903
Phone: 607-723-3539
Fax: 607-724-0549

Customer Service

If it is determined that your Wadia product is in need of repair, you can return it to your Dealer. You can also return it to the Wadia Service Department. For assistance on factory repair return procedure, contact the Wadia Service Department at:

Wadia Digital, LLC.
2 Chambers Street
Binghamton, New York 13903
Phone: 607-723-3539
Fax: 607-724-0549

Table of Contents

Safety Instructions	2
Thank You and About Wadia.....	3
Please Take a Moment	3
Technical Assistance and Customer Service	3
Table of Contents	3
General Information	4
Connector and Cable Information	4
Introduction.....	5
Performance Features	5
Dimensions	6
Installation	7
Rear Panel Connections and Switch	8
Connecting to a Preamplifier.....	9
Output Terminals and How to Connect.....	10-11
Front Panel Display and Push-Button.....	12
How to Operate.....	13
Specifications.....	14
Packing Instruction.....	15

General Information

1. For additional connection information, refer to the owner's manual(s) for any component(s) connected to the Wadia a102.
2. The Wadia a102 mutes the speaker output for approximately two seconds when first turned on.
3. For the best performance and safety it is important to always match the impedance of the Loudspeaker to the Wadia a102 Power Amplifier Connections (4 or 8 ohms). Refer to "How to Connect" pages 8 thru 11.

Note: The impedance of a Loudspeaker actually varies as the Loudspeaker reproduces different frequencies. As a result, the nominal impedance rating of the Loudspeaker (usually measured at a midrange frequency) might not always agree with the impedance of the Loudspeaker at low frequencies where the greatest amount of power is required. Contact the Loudspeaker Manufacturer for additional information about the actual impedance of the Loudspeaker before connecting it to the Wadia a102.

4. In the event the Wadia a102 overheats, due to improper ventilation and/or high ambient temperature, the protection circuits will activate. The Front Panel Standby/ON LED will start flashing. When the Wadia a102 has returned to a safe operating temperature, normal operation will resume.
5. The protection circuits will also activate when improper connections are made to the Loudspeaker Output Terminals.

Caution: The Loudspeaker Output ⊖ Negative Terminal Connections are not connected to chassis ground. Do not combine any of the Loudspeaker Output Terminals (⊕ Positive or ⊖ Negative) connections together, ground them or connect with another amplifier.

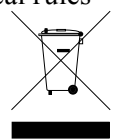
6. When discarding the unit, comply with local rules or regulations. Batteries should never be thrown away or incinerated but disposed of in accordance with the local regulations concerning battery disposal. 
7. For additional information on the Wadia a102 and other Wadia Products please visit the Wadia Web Site at www.wadia.com.

Connector and Cable Information

XLR Connectors

Below is the Pin configuration for the XLR Balanced Input Connectors on the a102. Refer to the diagram for connections:

- PIN 1: Shield/Ground
- PIN 2: + Output
- PIN 3: - Output

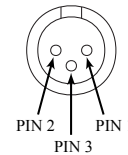

Trigger Control Connector

The Wadia a102 Trigger Control Input receives an On/Off signal from +5 to +12 volts. The Trigger Control Output will in turn provide a +12 volt Output Signal with a total current up to 50mA.

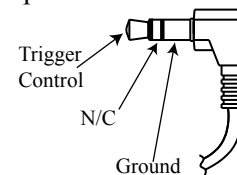

Output Terminal Connector

When cables with spade lugs are used for Loudspeaker Connection, the spade lugs need an opening of at least 3/10 inch (7.6mm).

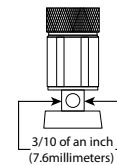

Introduction

The Wadia a102 Power Amplifier is one of the finest Digital Power Amplifiers available today. The 50 watts output per channel will drive any high quality Loudspeaker. The a102 reproduction is sonically transparent and absolutely accurate.

Performance Features

• **Balanced and Unbalanced Inputs**

Balanced connections allow long cable runs without compromising sound quality.

• **Amplifier and Loudspeaker Protection**

Built-in Thermal Protection Circuit guards against overheating. Provides Loudspeaker Protection when Direct Current is detected.

• **Power Supply**

The a102 Power Amplifier has several regulated power supplies, each one extremely stable to ensure noise free operation even though the power line varies.

• **Trigger Input and Output Connections**

The Trigger Input and Output connection provides convenient Turn-On/Off of additional Power Amplifiers and/or Source Components.

• **Gold Plated Connectors**

The Input and Output Connectors Contacts are gold plated for superior corrosion resistance and high electrical conductivity.

• **Custom Binding Posts**

Patented gold plated output terminals deliver high current output. They accept large diameter wire and spade lugs. Banana plugs may also be used only in the United States and Canada.

• **LED Front Panel Indicator**

A long life Light Emitting Diodes (LED) are used to indicate the operational status of the a102.

• **Die Cast Aluminium Chassis**

Maintains cool operating temperatures of the internal circuitry by the heat dissipating properties of the die cast aluminium chassis. The aluminium chassis with glass top panel is very durable and will retain its appearance for many years to come.

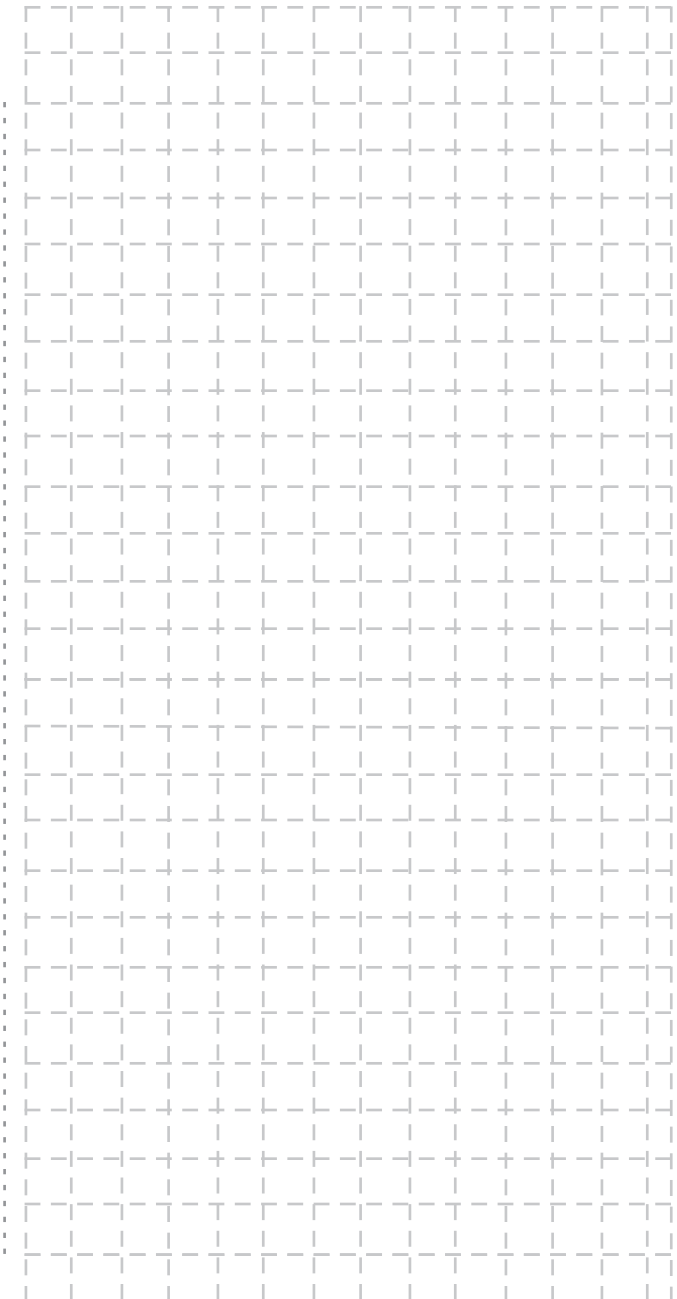

Dimensions

The following dimensions can assist in determining the best location for your a102. There is additional information on the next page pertaining to installing the a102 into cabinets.

Front View of the a102

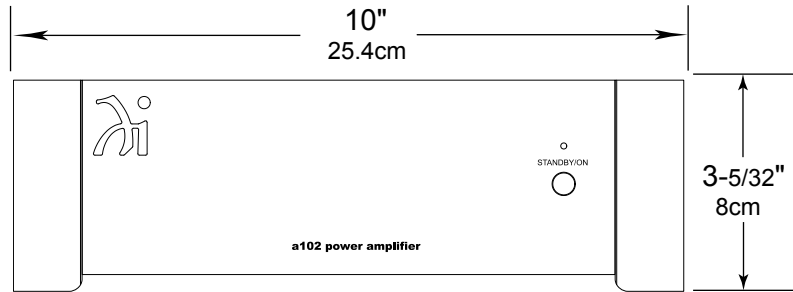

Side View of the a102

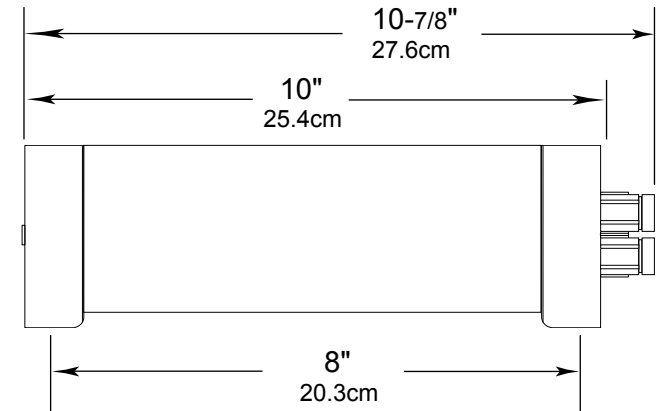

Rear View of the a102

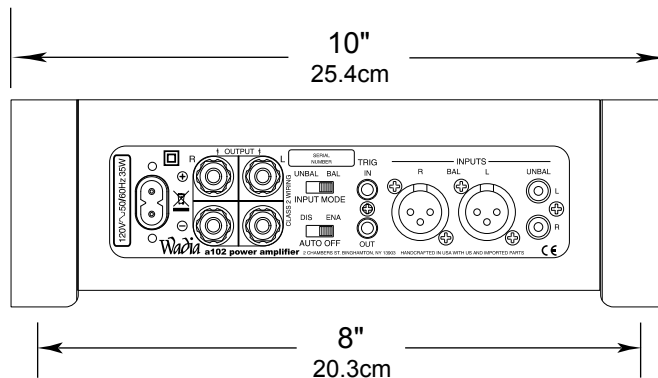

Installation

The a102 is designed to be placed upright on a table or shelf, standing on its feet. The ventilation requirements are shown.

Always provide adequate ventilation for your a102. Cool operation ensures the longest possible operating life for any electronic instrument. Do not install the a102 directly above a heat generating device, such as another Power Amplifier. Allow at least 2 inches (5.1cm) above the top, 5/8 inches (1.6cm) below the bottom and 2 inch (5.1cm) on each side of the a102, so that airflow is not obstructed. Allow 13 inches (33cm) of depth for airflow and cable connections.

a102 Front View

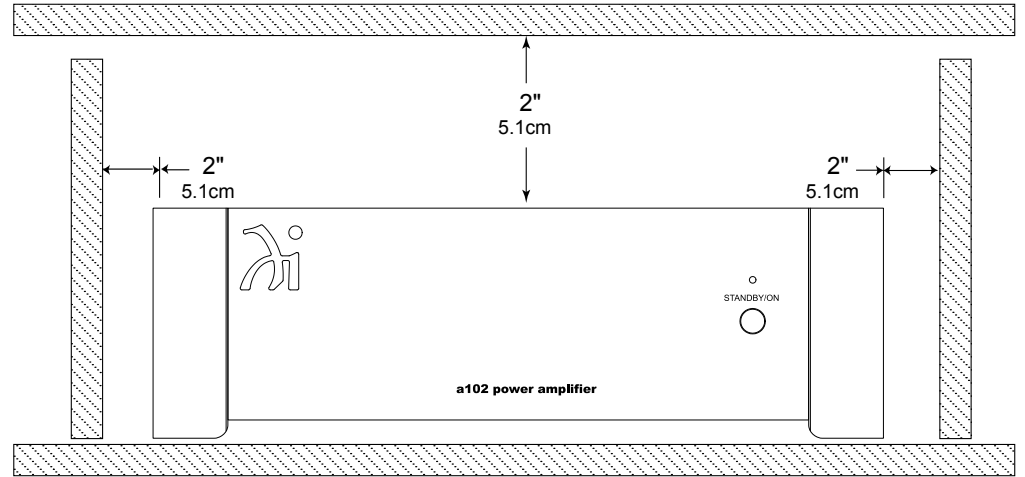

a102 Side View

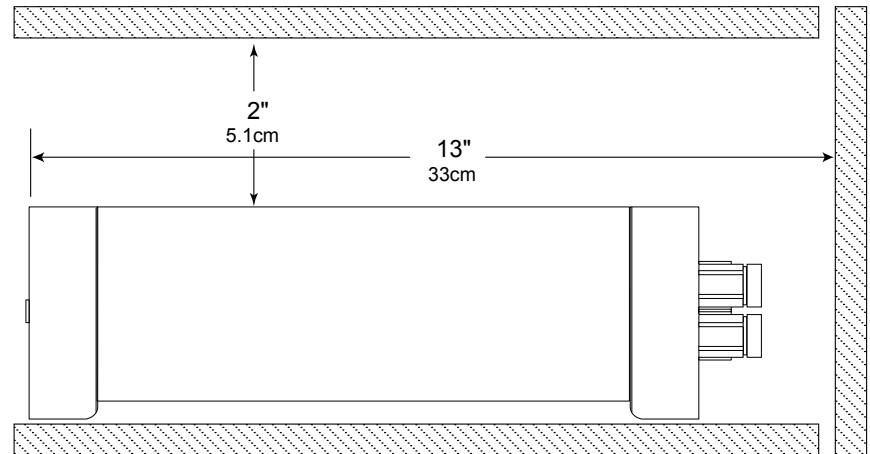

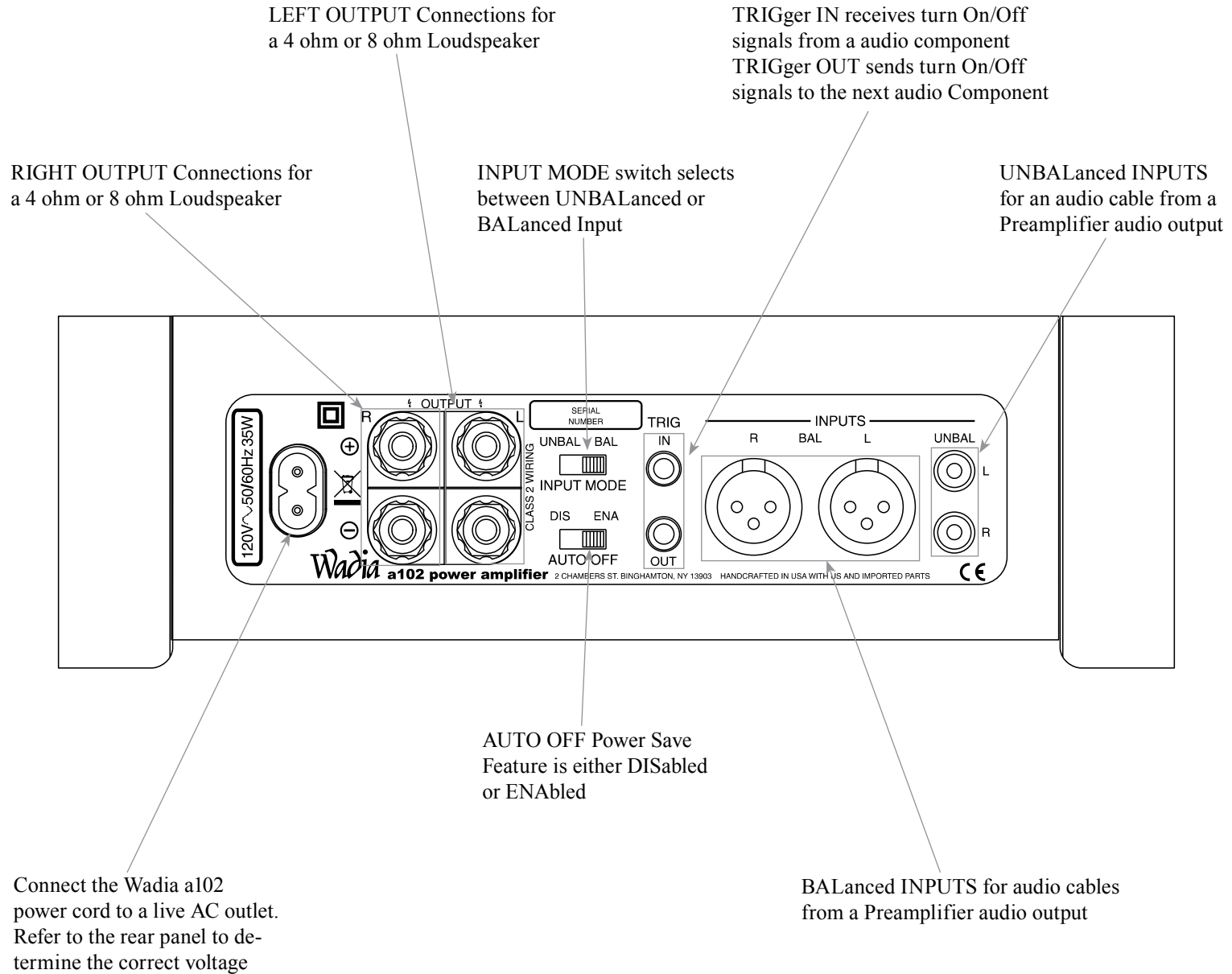

Caution: The Loudspeaker Output ⊖ Negative Terminal Connections are not connected to chassis ground. Do not combine any of the Loudspeaker Output Terminals (⊕ Positive or ⊖ Negative) connections together, ground them or connect with another amplifier.

Connecting to a Preamplifier

The connection instructions below with the diagram to the right is an example of a typical audio system. Your system may vary from this, however the actual components would be connected in a similar manner. For additional information refer to “Connector and Cable Information” on page 4.

1. For remote AC Power control of the a102, connect a control cable from the Audio Preamplifier or Source Device Trigger Out to the a102 TRIGGER IN.

Note: When a Triger Control Cable is connected between the a102 and Preamplifier/Source Device, the AUTO OFF Feature is bypassed. Refer to page 13.

2. Connect XLR cables from the Balanced Output (L&R) of an Audio Preamplifier/Source Device to the a102 BALANCED INPUTS (Right and Left).

Note: An optional hookup is to use an unbalanced cable(s) and place the INPUT MODE Switch in the UNBALANCED Position.

3. Proceed to “Output Terminals and How to connect” on page 10.

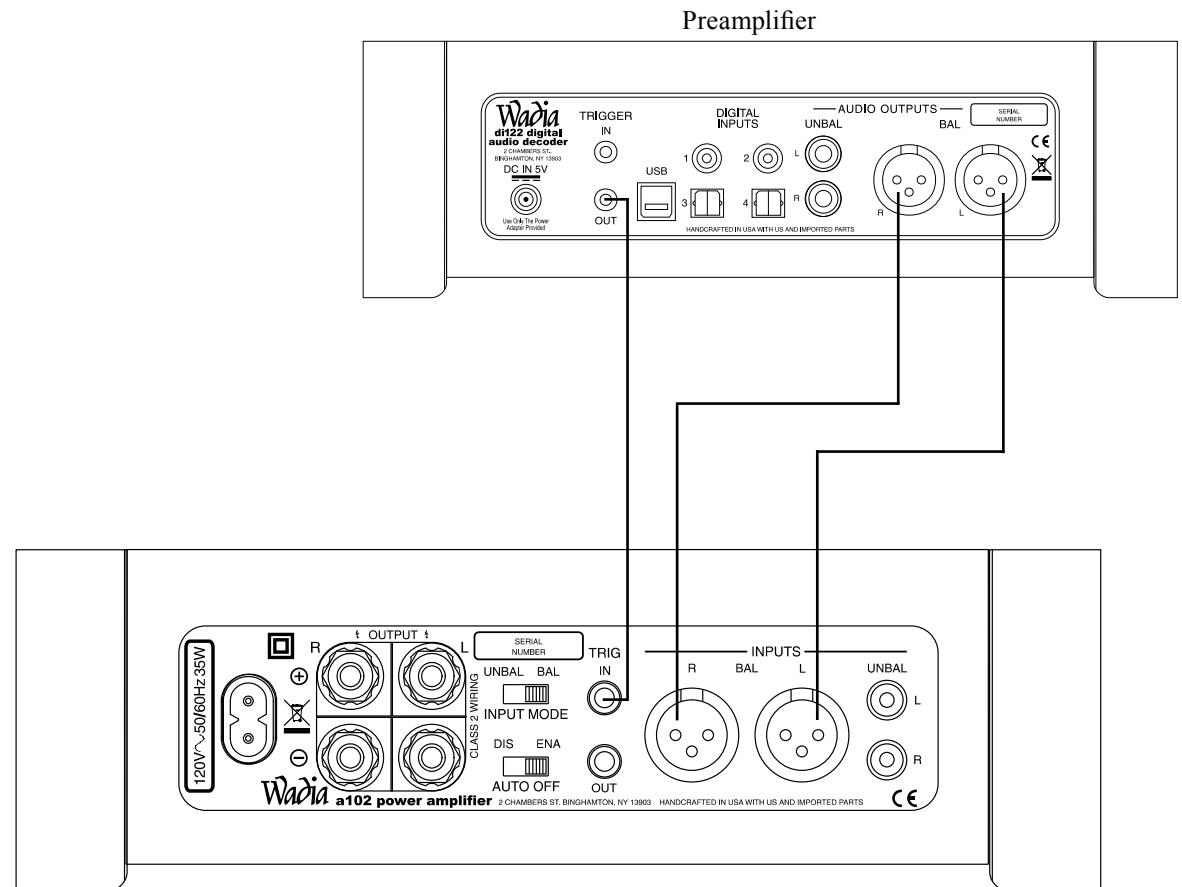



Output Terminals

When connecting the Loudspeaker Hookup Cables to the a102 Power Amplifier Output Terminals please follow the steps below:

1. Rotate the top of the Output Terminal Post counterclockwise until an opening appears. Refer to figures A and B.
2. Insert the Loudspeaker hookup cable into the Output Terminal Post opening or the cable spade lug around the center post of the Output Terminal. Refer to figure C.
3. Rotate the top of the Output Terminal Post clockwise until it is finger tight. Refer to figure D.
4. Place the supplied Wadia Wrench over the top of the Output Terminal and rotate it one quarter of a turn (90°) to secure the Loudspeaker Cable Connection. **Do not over tighten.** Refer to figure E.

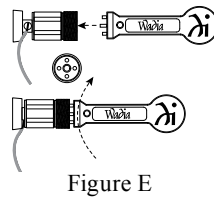
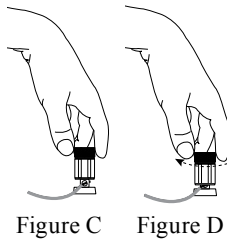
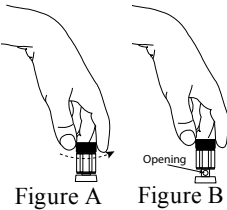

How to Connect

Caution: Do not connect the AC Power Cord to the a102 Rear Panel until after the Loudspeaker Connections are made. Failure to observe this could result in Electric Shock.

This Wadia a102 Power Amplifier is designed for Loudspeakers with an impedance of 4 ohms or 8 ohms. Connect a single Loudspeaker only to the Right and Left Output Terminals.

The connection instructions below, together with the illustration on the next page, is an example of

connecting typical Loudspeakers to the a102. Your Loudspeakers may vary from this, however the actual connections would be made in a similar manner.

When connecting Loudspeakers to the a102 it is very important to use cables of adequate size, so there is little to no power loss in the cables. The size is specified in Gauge Numbers or AWG (American Wire Gauge). The smaller the Gauge number, the larger the wire size:

Loudspeaker Cable Distance vs Wire Gauge Guide			
Loudspeaker Impedance	25 feet (7.62 meters) or less	50 feet (15.24 meters) or less	100 feet (30.48 meters) or less
4 Ohms	14AWG	12AWG	10AWG
8 Ohms	16AWG	14AWG	12AWG

1. Prepare the Loudspeaker Hookup Cable for attachment to the a102 Power Amplifier:

Bare wire cable ends:

Carefully remove sufficient insulation from the cable ends, refer to figures 2, 3 & 4. If the cable is stranded, carefully twist the strands together as tightly as possible.

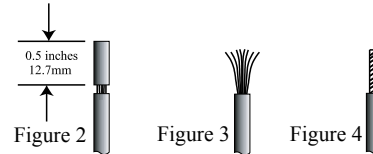

- Notes:
1. If desired, the twisted ends can be tinned with solder to keep the strands together.
 2. The prepared bare wire cable ends may be inserted into spade lug connectors.
 3. Banana plugs are for use in the United States and Canada only.

Banana Plugs are for use in the United States and Canada only:

2. Attach the previously prepared bare wire cable ends

into the banana plugs and secure the connections. Refer to figure F.

3. Rotate the top of the Output Terminal Post clockwise until it is finger tight. Refer to figure G. Then using the Wadia Wrench, rotate the top of the Output Terminal one quarter of a turn (90°).

Do not over tighten. Refer to figure E.

4. Referring to figure H, connect the Loudspeaker hookup cables with banana plugs into the hole at the end of the a102 Negative and Positive Output Terminals, being careful to observe the correct polarities.

Refer to “General Information” Note 3 on page 4 for additional information.

WARNING: Loudspeaker terminals are hazardous live and present a risk of electric shock. For additional instruction on making Loudspeaker Connections contact your Wadia Dealer or Wadia Technical Support.

5. Connect the a102 Power Cord to an active AC outlet.

Spade Lug or Wire Connections:

6. Connect the Loudspeaker hookup cables to the a102 Negative Output Terminal and Positive Output Terminal, being careful to observe the correct polarities. Insert the spade lug connector or prepared section of the cable end into the terminal side access hole, and tighten the terminal cap until the cable is firmly clamped into the terminals so the lugs or wire cannot slip out. Refer to figures 5 and 6.

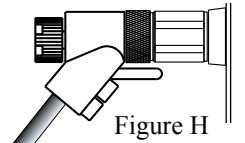
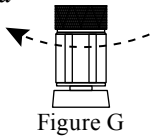
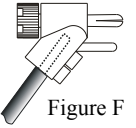

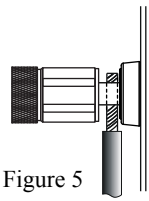

Figure 5

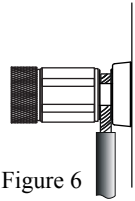
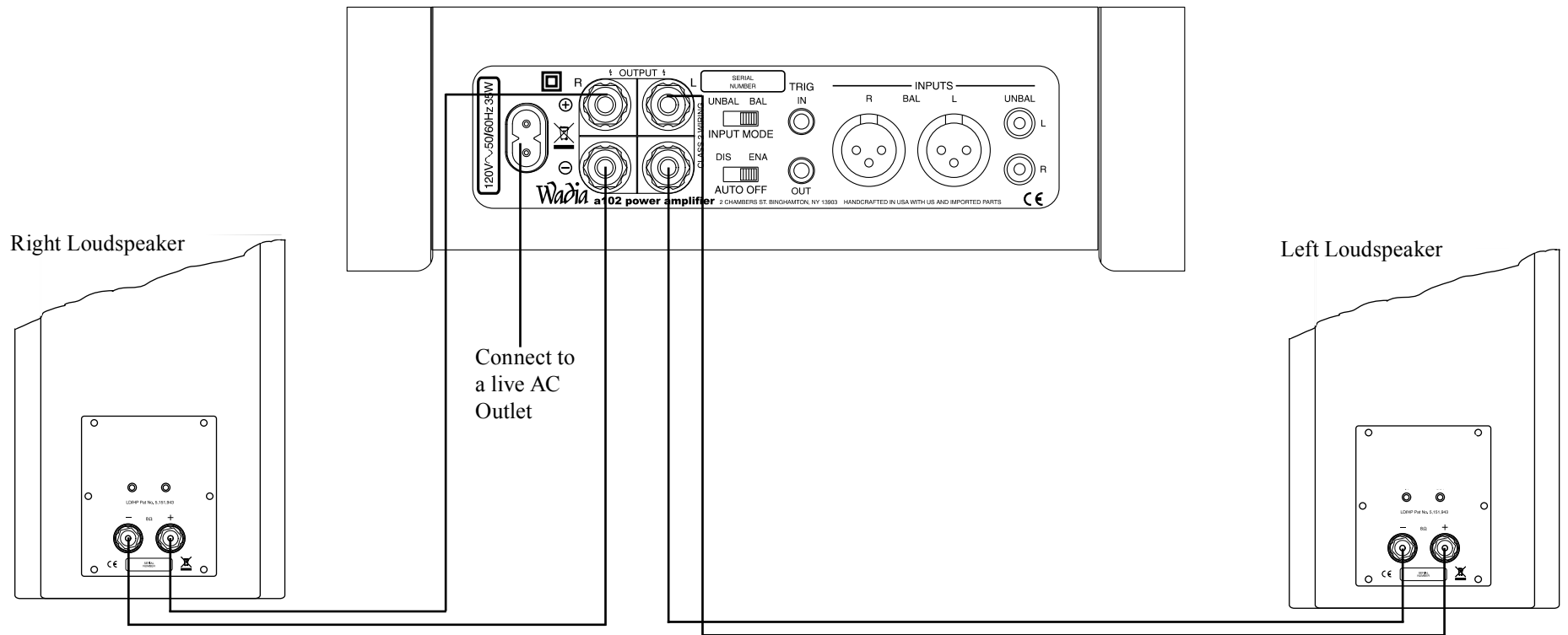

Figure 6

Refer to “General Information” Note 3 on page 4 for additional information.

WARNING: Loudspeaker terminals are hazardous live and present a risk of electric shock. For additional instruction on making Loudspeaker Connections contact your Wadia Dealer or Wadia Technical Support.

7. Connect the a102 Power Cord to an active AC outlet.



Caution: The Loudspeaker Output ⊖ Negative Terminal Connections are not connected to chassis ground. Do not combine any of the Loudspeaker Output Terminals (⊕ Positive or ⊖ Negative) connections together, ground them or connect with another amplifier.

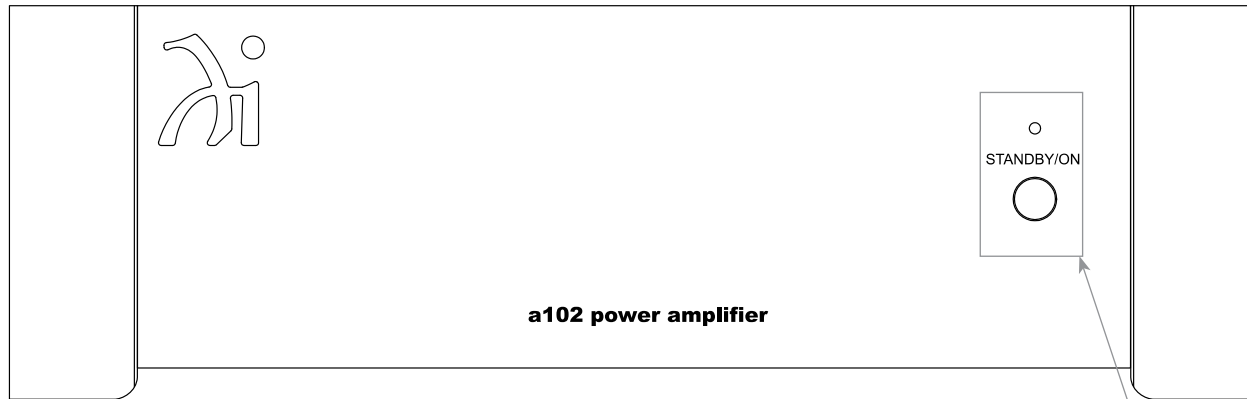

a102 power amplifier

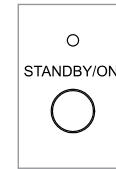

STANDBY/ON Push-button
with indicator, switches the
a102 ON or OFF (Standby)

How to Operate

Power On/Off

Momentarily press the POWER Push-button to switch the a102 On or Off. Refer to figure 7.

Note: There must be a Trigger Control Connection between the a102 and the Audio Preamplifier or Source Device, in order for the remote power turn-on to function.

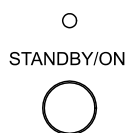

Figure 7

Auto Off

The a102 incorporates a Power Save Feature to automatically switch power Off to the Power Amplifier approximately 30 minutes after there has been an absence of an audio input signal.

Note: If the Power Save Feature has activated and switched the a102 Off, the Power Save Feature can be reset by momentarily pressing the STANDBY/ON Push-button.

When there is a Trigger Control Connection between the a102 and a Preamplifier or Source Device, the Power Save Feature in the a102 is bypassed.

With the a102 connected (via Trigger Control) to a Preamplifier (Source Device) with the Power Save Feature and the feature is active, the a102 will switch Off with the Preamplifier (Source Device) after a period of inactivity.

There may be times when it would be desirable to bypass the Power Save Feature, which by default is active. This can be implemented by placing the “AUTO OFF” Switch, located on the a102 Rear Panel, in the DIS (Disable) position.

Refer to figure 8.

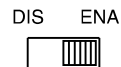

Figure 8

Input Mode Switch

The Input Mode Switch, which is located on the Rear Panel of the a102, allows selection of either the BALANCED or UNBALANCED Inputs. Refer to figure 9.

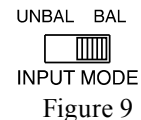
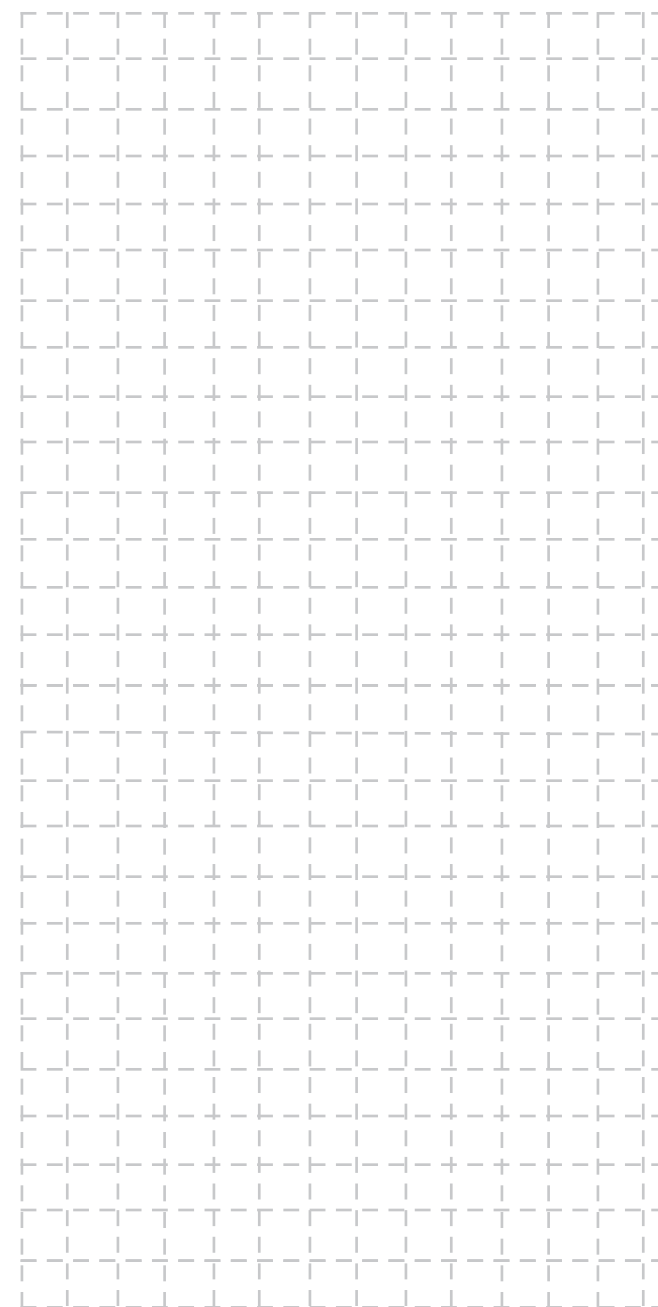

Figure 9





Specifications

Power Output

Minimum sine wave continuous average power output per channel, with both channels operating at 0.5% Total Harmonic Distortion is:
50 watts into 8 ohm load
80 watts into 4 ohm load

Output Load Impedance

8 or 4 ohms

Rated Power Band

20Hz to 20,000Hz

Total Harmonic Distortion

0.2% maximum harmonic distortion at any level from 250 milliwatts to one-half of rated power output, 20Hz to 20,000Hz.
0.5% maximum harmonic distortion at any level from one-half to full rated power output, 20Hz to 20,000Hz.

Dynamic Headroom

1dB, 8 ohm load
1.3dB, 4 ohm load

Frequency Response

+0, -0.5dB from 20Hz to 20,000Hz
+0, -3.0dB from 10Hz to 50,000Hz

Input Sensitivity (for rated output)

1.4 Volts Balanced
0.7 Volts Unbalanced

Signal To Noise Ratio (A-Weighted)

96dB (113dB below rated output) Balanced
93dB (110dB below rated output) Unbalanced

Intermodulation Distortion

0.1% maximum if the instantaneous peak power output does not exceed the rated power output, for any combination of frequencies from 20Hz to 20,000Hz.

Wide Band Damping Factor

Greater than 200, 8 Ohm load
Greater than 100, 4 Ohm load

Input Impedance

15,000 ohms Balanced
15,000 ohms Unbalanced

Voltage Gain

29dB

Trigger Input

5-15VDC, less than 1mA

Trigger Output

12VDC, 50mA maximum
Output is delayed 0.2 seconds from turn On

Note: All Specifications are with AC Line voltage of 120V.

General Specifications

Power Requirements

Field AC Voltage conversion of the a102 is not possible. The a102 is factory configured for one of the following AC Voltages:

100V ~ 50/60Hz at 35 Watts
110V ~ 50/60Hz at 35 Watts
120V ~ 50/60Hz at 35 Watts
220V ~ 50/60Hz at 35 Watts
230V ~ 50/60Hz at 35 Watts
240V ~ 50/60Hz at 35 Watts
Standby: less than 0.5 watt

Note: Refer to the rear panel of the a102 for the correct voltage.

Overall Dimensions

Width is 10 inches (25.4cm)
Height is 3-5/32 inches (8cm) including feet
Depth is 13 inches (33cm) including the Cables

Weight

8.5 pounds (3.9 kg) net, 10 pounds (4.5 kg) in shipping carton

Shipping Carton Dimensions

Width is 14-1/8 inches (35.9cm)
Height is 8 inches (20.3cm)
Depth is 14-1/8 inches (35.9cm)

Packing Instructions

In the event it is necessary to repack the equipment for shipment, the equipment must be packed exactly as shown below. It is very important to ensure the proper equipment location between the bottom and top foam pads. Failure to do this will result in shipping damage.

Use the original shipping carton and interior parts only if they are all in good serviceable condition. If a shipping carton or any of the interior part(s) are needed, please call or write Customer Service Department of Wadia. Refer to page 4. Please see the Part List for the correct part numbers.

<u>Quantity</u>	<u>Part Number</u>	<u>Description</u>
1	03456100	Shipping carton only
1	03456200	Top foam pad
1	03456000	Bottom foam pad

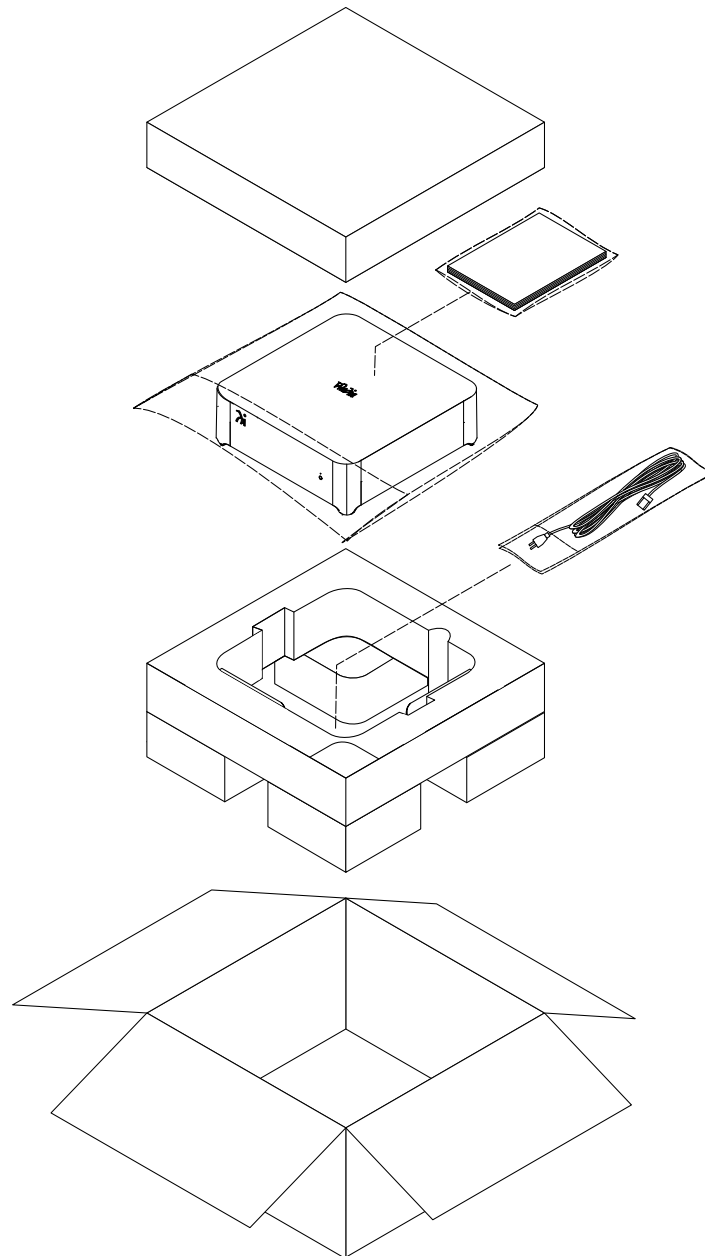



Wadia Digital, LLC
2 Chambers Street
Binghamton, NY 13903
www.wadia.com

The continuous improvement of its products is the policy of Wadia Digital who reserve the right to improve design without notice. Printed in the U.S.A.