

Low Temperature Polarization Effects in Ice

J. S. CHAMBERLAIN and N. H. FLETCHER

Department of Physics, University of New England, Armidale, N.S.W., Australia

Received August 4, 1970

When an initially unpolarized HF doped ice specimen is warmed at a constant rate in an applied electric field two peaks are observed in the current. The low temperature peak occurs near 100°K and the temperature at which this peak occurs is seen to increase as the HF concentration decreases. The second peak appears to occur randomly in the temperature range 125–135°K. These peaks are also observed if the sample is cooled in an applied electric field and then warmed at a constant rate with the field removed. It is suggested that the first peak is due to a dielectric relaxation process which is governed by the L defects released from the HF molecules. This release of L defects is shown to obey the law of mass action with an activation energy for liberation of an L defect of 0.12 ± 0.06 eV and a dissociation constant $k_0^L \approx 10^{29} \text{ m}^{-3}$.

A simple theoretical model of ice is also developed which predicts the current reversal phenomenon observed by Dengel *et al.* [11] suggesting that it is due to dipole relaxation and not to ferroelectric ordering.

Wenn eine anfänglich unpolarierte, HF-dotierte Eisprobe mit konstanter Aufheizrate bei angelegtem elektrischem Feld erwärmt wird, beobachtet man zwei Maxima des Stromes. Der temperaturmäßig tieferliegende Höchstwert tritt bei etwa 100°K auf, nämlich bei einer Temperatur, welche mit sinkender HF-Konzentration zunimmt. Das höherliegende Strom-Maximum tritt ungesetzmäßig im Temperaturbereich von 125–135°K auf. Beide Maxima werden auch dann beobachtet, wenn eine in einem elektrischen Felde abgekühlte Eisprobe nach Abschalten des Feldes mit konstanter Aufheizrate erwärmt wird.

Das untere Strom-Maximum wird einem dielektrischen Relaxationsprozeß zugeschrieben, welcher durch L-Defekte bestimmt wird, die von HF-Molekülen stammen. Es wird gezeigt, daß die Freisetzung der L-Defekte dem Massenwirkungsgesetz gehorcht mit einer Aktivierungsenergie für die Freisetzung eines L-Defekts von 0.12 ± 0.06 eV und einer Dissoziationskonstanten $k_0^L \approx 10^{29} \text{ m}^{-3}$.

Ein einfaches theoretisches Modell für Eis wird entwickelt, welches die von Dengel *et al.* [11] beobachtete Vorzeichenumkehr des Stromes voraussagt und darauf hindeutet, daß sie einer Dipolrelaxation und nicht einem ferroelektrisch geordneten Zustand zuzuschreiben ist.

Quand un spécimen de glace initialement non-polarisé et doté de HF se chauffe à un taux constant dans un champ électrique appliqué, on observe deux pics dans le courant. Le pic à la température la plus basse se produit à environ 100°K et la température à laquelle ce pic se produit augmente à mesure que la concentration de HF diminue. La deuxième pic paraît se produire au hasard entre les températures 125–135°K. On observe aussi ces pics si l'échantillon se refroidit dans un champ électrique appliqué et puis se réchauffe à un taux constant après l'enlèvement de ce champ. On suggère que la premier pic est due à un processus de relaxation diélectrique que régissent les défauts L libérés des molécules HF. On prouve que cette libération de défauts L obéit à la loi d'action de masse, avec une énergie d'activation pour la libération d'un défaut L de 0.12 ± 0.06 eV et une constante de dissociation $k_0^L \approx 10^{29} \text{ m}^{-3}$.

On développe aussi un simple modèle de glace théorique qui prédit le phénomène de renversement de courant observé par Dengel *et al.* [11], ce qui suggère que ce phénomène est dû à la relaxation dipolaire et non pas à la mise en ordre ferroélectrique.

Introduction

The question of a possible ferroelectric ordering in ice has been considered since Pauling [1] calculated the zero-point entropy in terms of proton disorder. He assumed that the energy differences between all the possible molecular configurations are so small that they may be all considered equally probable and obtained a zero-point entropy in excellent agreement with the experimentally determined value of Giauque and Stout [2]. Nevertheless the possibility exists that at low enough temperatures the energy differences may be large enough compared with kT to promote ordering before the molecular configurations are frozen in. Bjerrum [3] attempted to calculate the energy differences between several different types of configurations but his results were largely negated by Pitzer and Polissar [4]. Rundle [5, 6, 7] proposed a partially disordered model in which only protons along the c -axis bonds were ordered. Peterson and Levy [8] however carried out neutron diffraction studies on D_2O at $223^\circ K$ and $123^\circ K$ which confirmed the Pauling model and showed the Rundle model to be untenable. They also found no evidence of superlattice lines.

The observation of proton ordering in two of the high pressure polymorphs of ice [9, 10] and the observation of ferroelectric type behaviour [11] has created a recent upsurge of interest in a possible ferroelectric transition in ice I_h near $100^\circ K$. Anomalies have been observed near this temperature in the specific heat [12, 13], the longitudinal elastic constants [14] and the electrical polarization [15–19] of both pure and HF doped ice.

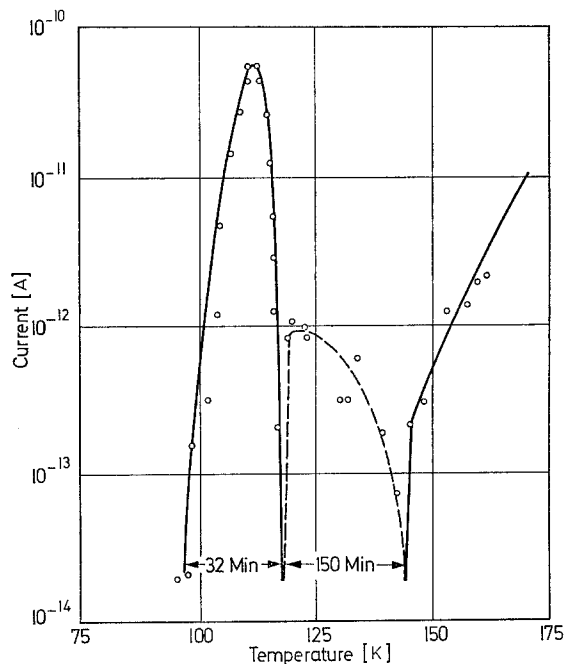

Fig. 1. Current observed in a slowly heated ice sample with an applied field of 40 kV m^{-1} . Dashed line indicates current in the reverse direction (after [11])

In particular the report of Dengel *et al.* [11] warrants further consideration. Unfortunately this work has been reported in outline only and so is difficult to completely assess. Their experiments consisted of warming or cooling, at a constant rate, an ice sample in an applied electric field. How closely this constant rate was realized is not apparent since the times given on their experimental plot, reproduced in Fig. 1, appear to contradict this. Nevertheless the current which flows was seen to reverse sign and flow against the direction of the applied field in the temperature range 120–145 °K. As a supplement to these experiments the dielectric constant of the sample was measured over the temperature range 75–150 °K by evaluating the time integral of the charging and discharging currents which occurred when an electric field was applied or removed. The dielectric constant was observed to have a peak value of about 300 at 100 °K. However the authors noted that the above effects only occurred when the samples were “not extremely pure” and so could not decide whether the behaviour was due to the impurity atoms themselves or whether they merely reduced the relaxation time for ferroelectric ordering in ice. Onsager [20] has recently suggested that the addition of HF may also promote this ordering process.

Experimental Procedure

As a further study of the polarization effects in ice at low temperatures we have carried out a series of experiments similar to those of Dengel *et al.* [11] and of Bishop and Glen [15] on samples with varying HF content.

The ice samples were grown from water which had been distilled and deionized (conductivity at 50 Hz $\leq 5 \times 10^{-7} \Omega^{-1} \text{cm}^{-1}$ at 20 °C). This water was then added to a stock solution of A.R. grade HF and the solution diluted to the desired HF concentration. The HF concentration in the stock solution was determined by titration against NaOH. The solution was carefully outgassed by boiling under vacuum and then poured into the growth vessel. This vessel had a gold-plated brass base of 2.2 cm diameter and perspex walls 2.5 cm high and 0.2 cm thick. The brass was held at 256 °K in a freezer and a polycrystalline sample was grown. Polycrystalline samples were used because the HF content of the sample is known much more accurately than with single crystals. However it was realised that the effects observed could be due to grain boundary effects and so several measurements were made on a single crystal specimen with a nominal HF concentration of 10^{24}m^{-3} . The behaviour observed was similar to that of polycrystalline samples. During growth the ice interface moved from the bottom upwards and much of the HF segregated at the top of the sample. This meant that the crystal had to be annealed for at least four days after growth to allow the HF to become approximately uniformly distributed throughout the crystal. The diffusion coefficient of HF in ice is $\sim 10^{-7} \text{cm}^2 \text{s}^{-1}$ [21, 22] and calculations show that the concentration variation along the sample after four days should not be greater than about 5%.

After all the water had been frozen, another gold plated brass disc was frozen onto the top of the sample. The sample thickness was usually about 0.75 cm. The whole assembly was then placed in the measuring apparatus shown in Fig. 2. This apparatus was placed in a Dewar flask and the aluminium rod could be

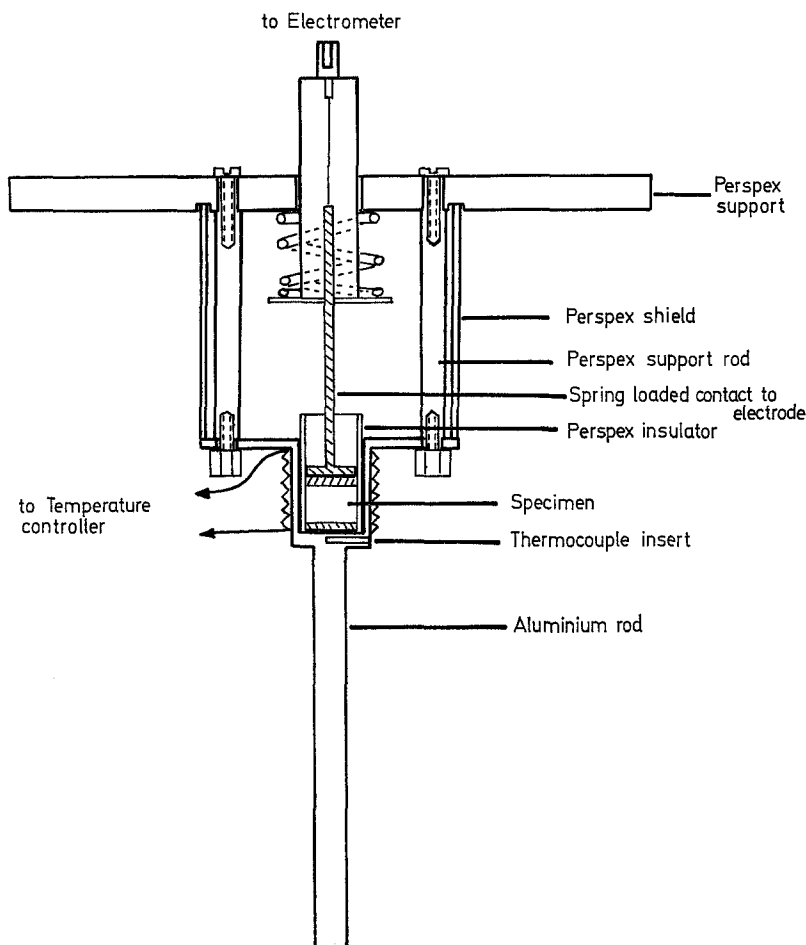

Fig. 2. Apparatus used for current measurements

immersed in liquid nitrogen up to the thermocouple insert. The temperature of the specimen was set by a motorized fixed-point temperature controller which powered the heating coils.

Before commencing any experimental work, the temperature gradient across a typical sample was measured when held at different steady temperatures and also when heated or cooled at different rates. For a sample 1 cm thick the temperature gradient did not exceed $2\text{ }^{\circ}\text{K cm}^{-1}$ when held at a constant temperature in the range $80\text{--}150\text{ }^{\circ}\text{K}$. When warming or cooling at rates up to $1.5\text{ }^{\circ}\text{K min}^{-1}$, temperature gradients of up to $10\text{ }^{\circ}\text{K cm}^{-1}$ were obtained. However if the sample was allowed to stand at $77\text{ }^{\circ}\text{K}$ for at least 30 minutes before warming was commenced, then for heating rates up to $1.5\text{ }^{\circ}\text{K min}^{-1}$ the temperature gradient did not exceed $2\text{ }^{\circ}\text{K cm}^{-1}$ at temperatures below $130\text{ }^{\circ}\text{K}$. The polarization or depolarization current was determined by measuring, with an electrometer, the voltage developed across a $10^{10}\text{ }\Omega$ resistor in series with the crystal. Since the

internal resistance of the crystals is $\geq 10^{12} \Omega$ at 77 °K, then any thermoelectric voltages should be essentially shorted out. The main effect of a temperature gradient should therefore only be to broaden the observed peaks.

The experiments performed were of two types:

(i) The sample was cooled to 77 °K and left at that temperature for 30 minutes. An electric field was then applied and the sample warmed at approximately $1.5 \text{ }^\circ\text{K min}^{-1}$. The current-temperature curve was plotted on an X-Y recorder while the heating rate was monitored on a single channel X-t recorder.

(ii) The sample was cooled to a fixed temperature and an electric field $\sim 100 \text{ kV m}^{-1}$ was applied. The sample was then cooled at approximately $10 \text{ }^\circ\text{K min}^{-1}$ to 77 °K, when the field was removed and the sample connected to the electrometer. The sample was then warmed at a rate of approximately $1.5 \text{ }^\circ\text{K min}^{-1}$ and a current-temperature plot recorded, the heating rate again being monitored as in (i).

In both cases the current was recorded over the temperature interval 77 to 150 °K and the rate of temperature rise was constant to within $\pm 0.1 \text{ }^\circ\text{K min}^{-1}$.

Experimental Results

When an initially unpolarized sample is warmed in an applied electric field, two peaks are observed in the current as shown in Fig. 3. After the second peak

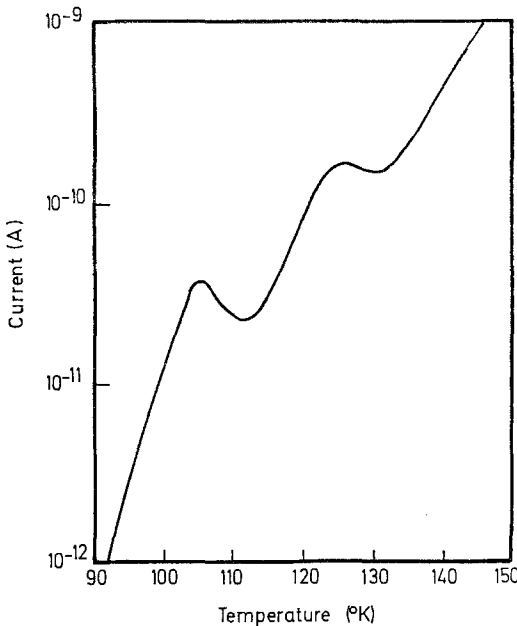

Fig. 3

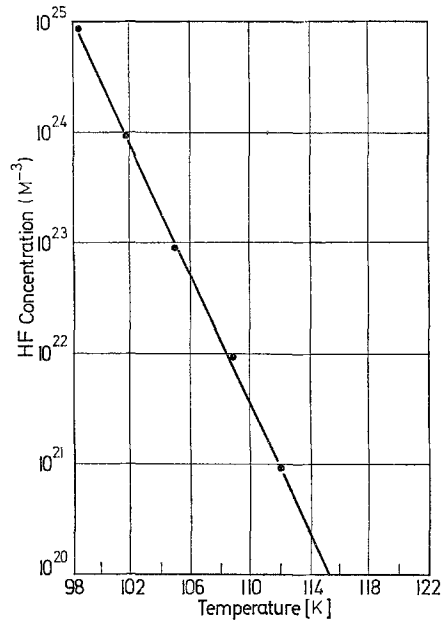

Fig. 4

Fig. 3. Typical curve, on a logarithmic scale, for a HF doped ice sample warmed at $1.5 \text{ }^\circ\text{K min}^{-1}$ in an applied field of 40 kV m^{-1} ($[\text{HF}] = 9.2 \times 10^{22} \text{ m}^{-3}$)

Fig. 4. HF concentration versus temperature at which the current peak occurs for specimens warmed at $1.5 \text{ }^\circ\text{K min}^{-1}$

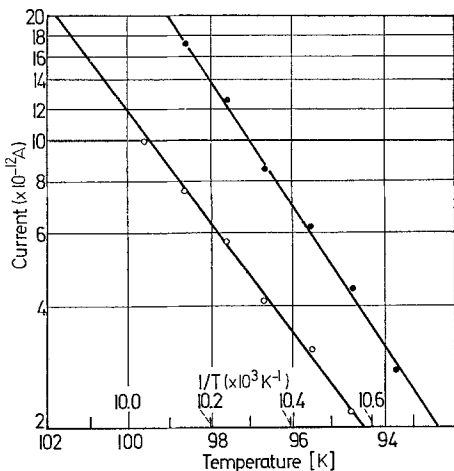

Fig. 5

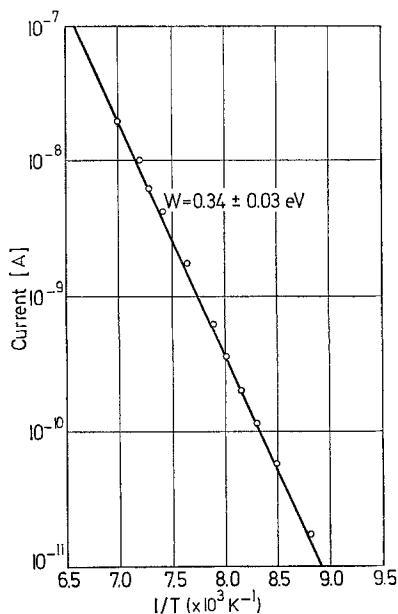

Fig. 6

Fig. 5. Typical plots of log current versus reciprocal temperature for the low temperature tails of the current peaks. The samples were warmed at $1.5^\circ\text{K min}^{-1}$ in a field of 40 kV m^{-1} . Curve I: HF concentration in sample $= 9 \times 10^{20}\text{ m}^{-3}$; Curve II: HF concentration in sample $= 9 \times 10^{22}\text{ m}^{-3}$

Fig. 6. A plot of log current versus reciprocal temperature at temperatures above the current peaks. The sample was warmed in an applied field of 10 kV m^{-1} at $1.5^\circ\text{K min}^{-1}$ and contained 10^{25} m^{-3} HF

the current continues to rise exponentially. The second peak occurs apparently randomly over the temperature range $125\text{--}135^\circ\text{K}$ and is also observed in pure ice specimens. The first peak however appears reproducibly near 100°K . The area under the peak and hence the charge released for a given field is constant over the range of HF concentrations $10^{20}\text{--}10^{25}\text{ m}^{-3}$ and, for a field of 40 kV m^{-1} , corresponds to a surface charge density of about $3 \times 10^{-5}\text{ C m}^{-2}$. The temperature at which the peak occurs depends on the HF concentration and increases as the HF concentration is decreased (see Fig. 4).

The charge release was also observed to vary linearly with applied fields up to 40 kV m^{-1} . If fields much larger than this were applied then large current pulses ($\sim 5 \times 10^{-12}\text{ A}$) were observed to occur over all the temperature range considered. This effect appeared to increase with increasing HF concentration.

If the charge release process is assumed to obey first order kinetics, then a plot of the logarithm of the current, I , versus reciprocal temperature for the low temperature tail of the peak should be a straight line [23]. Fig. 5 shows two such plots and, from a series of these, an activation energy of $0.30 \pm 0.03\text{ eV}$ is obtained. Further, a plot of the logarithm of the current after the second peak versus reciprocal temperature also yields a straight line (Fig. 6) and the activa-

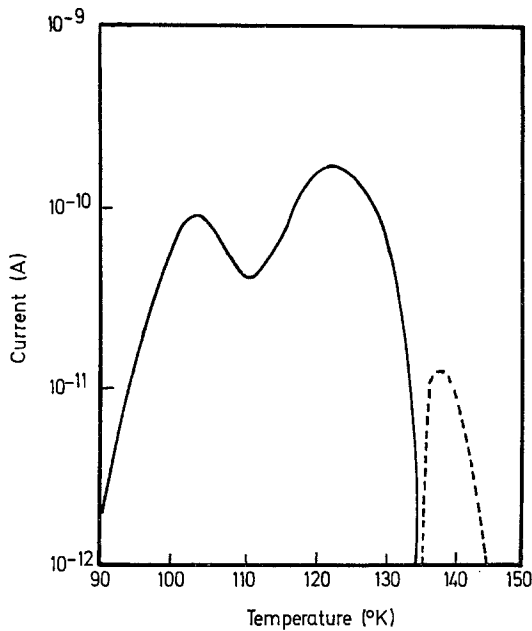

Fig. 7. A typical depolarization curve for ice doped with HF ($[HF] = 9 \times 10^{22} \text{ m}^{-3}$) after being cooled at $10^\circ\text{K}/\text{min}$ in an applied field of 100 kV m^{-1} . The sample was warmed at $1.5^\circ\text{K min}^{-1}$. The dashed line indicates current in the reverse direction

tion energy calculated from the slope is $0.34 \pm 0.03 \text{ eV}$. However the absolute magnitude of this current was observed to vary by as much as an order of magnitude for samples with nominally the same HF concentration.

If the sample was cooled from 130°K in an applied field, so that it became polarized, and was then warmed with the field removed, two peaks were again observed at about 100°K and 125°K . The charge release associated with the low temperature peak was constant over the HF concentration range 10^{20} to 10^{25} m^{-3} and the temperature at which the peak occurred increased as the HF concentration was decreased. A typical plot on a logarithmic scale is shown in Fig. 7. The surface charge density associated with the first peak for an applied field during cooling of 100 kV m^{-1} is about $6 \times 10^{-5} \text{ C m}^{-2}$. A plot of the logarithm of the current versus reciprocal temperature for the low temperature tail of this peak also gives a straight line and an activation energy of $0.30 \pm 0.03 \text{ eV}$.

Another interesting phenomenon observed in this second type of experiment is the current reversal which occurs for most HF doped samples. This reversal is seen to occur in Fig. 7 over the temperature range $135\text{--}145^\circ\text{K}$. The temperature at which this reversal occurs increases as the HF content of the sample decreases but as yet no explanation can be offered — it may well be just an electrode effect.

If the measurements are commenced only a day after sample growth, then the polarization associated with both peaks is much smaller than that observed after four days. The low temperature peak also occurs at a lower temperature but

moves up to higher temperatures over following days. If the peak position and polarization are reproducible from one day to the next then it is assumed that the HF has diffused uniformly throughout the crystal. This generally occurs after four days. This behaviour agrees qualitatively with observations of Bishop and Glen [15] and seems to indicate that the effect giving rise to the main peaks is a bulk property of the ice but localized to the HF doped region.

Discussion and Theory

The experimental results have led us to believe that the observed effects, at least for the peak at $\sim 100^\circ\text{K}$ are due to a bulk property of the ice. This probably means that the water molecules are being oriented in the applied electric field, the relaxation time for this process being governed by the L defect concentration which is determined by the HF concentration.

To analyse the situation more fully, let us consider a simple model for an ice crystal. Let us suppose it is a solid containing permanent dipoles of moment μ which may be oriented by an applied electric field E with a characteristic relaxation time τ which has a classical activation energy W so that

$$\tau = \tau_0 \exp(W/kT). \quad (1)$$

The equilibrium polarization P_∞ of such a solid in an applied field E at temperature T is given by the Langevin-Debye equation as

$$P_\infty = \frac{N\alpha\mu^2 E}{kT} \quad (2)$$

provided that $\mu E \ll kT$. Typically $\mu \approx 3$ Debye, $E = 40 \text{ kV m}^{-1}$ and $T = 100^\circ\text{K}$ so $\mu E/kT \approx 3 \times 10^{-4}$. N is the dipole concentration, in this case just the concentration of water molecules in ice, k is Boltzmann's constant and α is a factor taking account of the freedom of the dipoles to rotate and also their mutual interaction.

To estimate α we note that the static dielectric constant ϵ_s may be expressed as

$$\epsilon_s - \epsilon_\infty = \frac{P_\infty}{\epsilon_0 E} = \frac{N\alpha\mu^2}{\epsilon_0 kT} \quad (3)$$

where ϵ_0 is the permittivity of free space, and ϵ_∞ is the high-frequency permittivity.

Fröhlich [24] has developed a general formulation to calculate the dielectric constant of a material. He considered a spherical region inside the specimen large enough for the material outside to be treated macroscopically. Within this sphere is chosen a smaller region in any position not near the surface, the moment of the region being $m(x_j)$ when the elementary charges within it are fixed in positions characterized by x_j . The average moment of the sphere immersed in its own medium, with x_j fixed, is called $m^*(x_j)$. The average value of mm^* for all possible x_j , taking account of the probability of each configuration, is calculated and the static dielectric constant is then given as

$$\epsilon_s - n^2 = \frac{3\epsilon_s}{(2\epsilon_s + n^2)} \cdot \frac{N}{3\epsilon_0} \left(\frac{n^2 + 2}{3} \right)^2 \frac{\langle mm^* \rangle}{kT} \quad (4)$$

where n is the refractive index of the material.

This is the form used by Powles [25] and is only strictly true if $\langle mm^* \rangle$ is calculated in terms of the vacuum dipole moments of the molecules under consideration. The model for a molecule in this treatment is taken as a point dipole immersed in a sphere of dielectric constant n^2 .

Powles calculated mm^* taking as his unit of moment $m(x_j)$ a water molecule. Using a point charge model of the water molecule to calculate the energies of interaction between the molecules he obtained for a group of seventeen molecules a value of $\langle mm^* \rangle = 3.5 \mu_v^2$ where μ_v is the vacuum dipole moment of a water molecule. This result agrees reasonably well with the experimental results of Auty and Cole [26] which gave values of $\langle mm^* \rangle / \mu_v^2$ between 3.15 and 3.54 in the temperature interval 207–273 °K.

Now from (4), adopting Powles' value for $\langle mm^* \rangle$,

$$\epsilon_s - n^2 = \frac{3 \epsilon_s}{2 \epsilon_s + n^2} \cdot \frac{N}{3 \epsilon_0} \left(\frac{n^2 + 2}{3} \right)^2 \frac{3.5 \mu_v^2}{kT}. \tag{5}$$

If we allow for atomic and molecular vibrational contributions to the dielectric constant then we may replace n^2 by ϵ_∞ , the high-frequency dielectric constant, and, since $\epsilon_s \gg \epsilon_\infty$ for ice, (5) becomes

$$(\epsilon_s - \epsilon_\infty) = \frac{3}{2} \cdot \frac{N}{3 \epsilon_0} \cdot \left(\frac{\epsilon_\infty + 2}{3} \right)^2 \cdot \frac{3.5 \mu_v^2}{kT}. \tag{6}$$

Comparing (6) and (3) we obtain

$$\alpha = \frac{1}{2} \left(\frac{\epsilon_\infty + 2}{3} \right)^2 3.5 \frac{\mu_v^2}{\mu^2}.$$

Now μ , the moment of the molecule in the solid is given [24] by

$$\mu = \frac{\epsilon_\infty + 2}{3} \mu_v$$

and hence $\mu = 3.23$ Debye and $\alpha = 1.75$.

In view of the simple model used for a molecule in the treatment of Fröhlich, these results can only be regarded as approximations but nevertheless, they prove useful for comparison between theory and experiment.

Suppose that an electric field E is applied to a previously unpolarized sample at a time $t = 0$ when the sample temperature is T_0 . The sample is then warmed or cooled at a constant rate b and we wish to determine the current density j and polarization P at any temperature T . The differential equation governing the polarization process is

$$j = \frac{dP}{dt} = b \cdot \frac{dP}{dT} = \frac{P_\infty - P}{\tau}. \tag{7}$$

Using (1) and (2) this can be put in the form

$$\frac{dy}{dT} + Bye^{-ClT} = -\frac{A}{T^2} \tag{8}$$

where

$$A = \frac{N\alpha\mu^2 E}{k}, \quad B = \frac{1}{b\tau_0}, \quad C = \frac{W}{k}$$

and $y = (A/T) - P$.

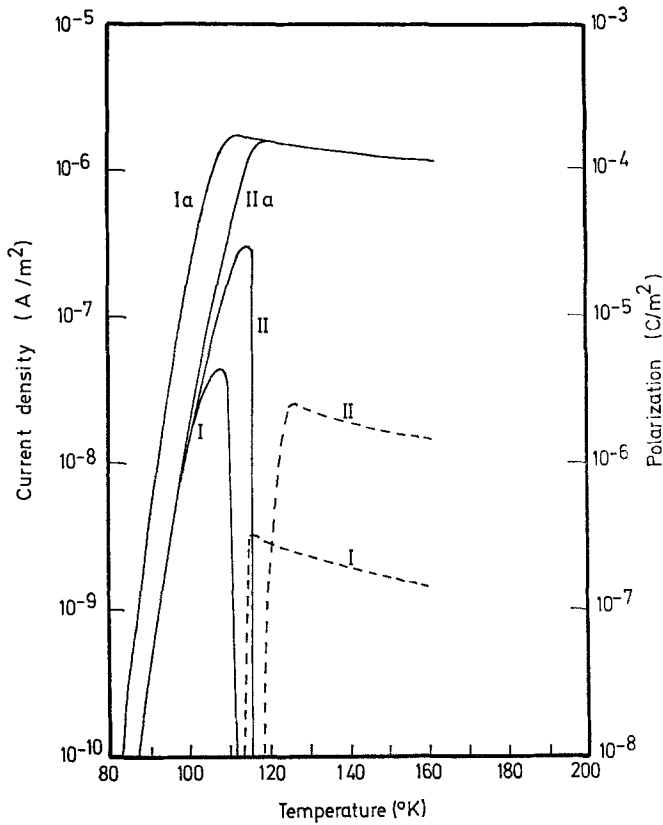

Fig. 8. Theoretical current and polarization curves for an ice sample warmed in an applied field of 40 kV m^{-1} with $\tau_0 = 10^{-11}$ sec. Curve I — current density for $b = 0.12^\circ\text{K min}^{-1}$; Curve Ia — polarization for $b = 0.12^\circ\text{K min}^{-1}$; Curve II — current density for $b = 1.2^\circ\text{K min}^{-1}$; Curve IIa — polarization for $b = 1.2^\circ\text{K min}^{-1}$. The dashed lines indicate current in the reverse direction to the applied field

The integrating factor for (8) is

$$R(T) = \exp\left[\int B e^{-C/T} dT\right]$$

which can be expressed as

$$R(T) = \exp[BT \exp(-C/T) - BC E_1(C/T)] \tag{9}$$

where $E_1(x)$ is the exponential integral

$$E_1(x) = -\text{Ei}(-x) = \int_x^\infty t^{-1} e^{-t} dt$$

which may be readily evaluated [27]. Using (9) as the integrating factor for (8) now gives

$$y = \frac{1}{R(T)} \left\{ R(T_0) y_0 - \int_{T_0}^T \frac{A}{T^2} R(T) dT \right\} \tag{10}$$

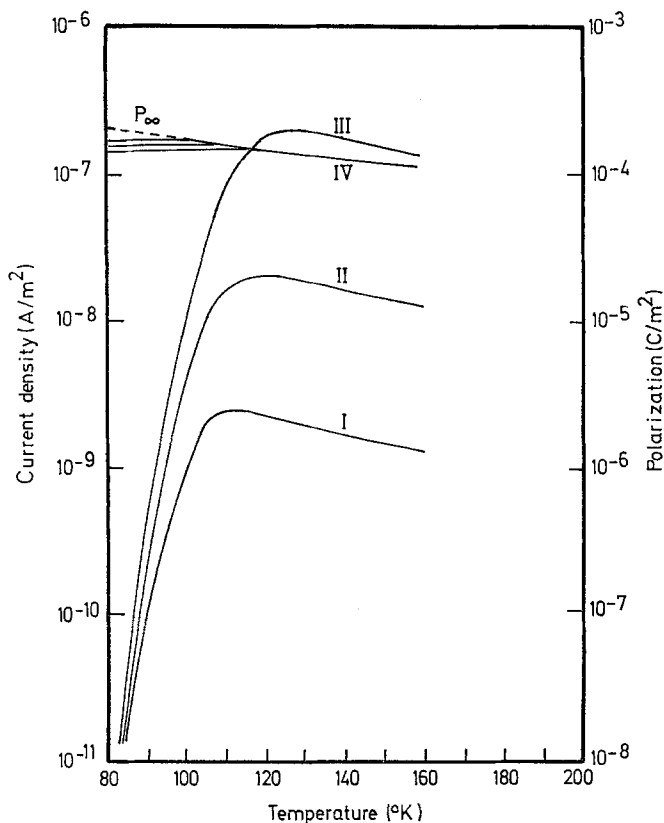

Fig. 9. Theoretical current and polarization curves for an ice sample cooled in an applied field of 40 kV m^{-1} with $\tau_0 = 10^{-15} \text{ s}$. Curve I — current density for $b = 0.12^\circ\text{K min}^{-1}$; Curve II — current density for $b = 1.2^\circ\text{K min}^{-1}$; Curve III — current density for $b = 12^\circ\text{K min}^{-1}$; Curve IV — polarization curves. Note that the polarization becomes “frozen-in”. The smallest “frozen-in” polarization corresponds to the highest cooling rate

where y_0 is the value of y when $t = 0$ and $T = T_0$. From (7) the experimental quantity j is given in terms of y by

$$j = b \frac{dP}{dT} = \frac{y}{\tau} \tag{11}$$

and the instantaneous polarization P at temperature T is given by

$$P = \frac{A}{T} - y. \tag{12}$$

To evaluate (10) and hence (11) and (12), values for W and τ_0 were derived from the experimental low temperature peaks in HF doped ice. Typical plots of behaviour for both rising and falling temperatures are shown in Figs. 8 and 9. The theoretical curves show that the current reverses direction somewhere in the temperature range $98\text{--}130^\circ\text{K}$ depending on the value of τ_0 and the heating rate. This is what was observed by Dengel *et al.* [11] and it is tempting to speculate that these authors were seeing the expected behaviour of a material containing

permanent dipoles having a characteristic relaxation time for orientation, when warmed in an applied electric field. The theory however does not predict a current reversal when the material is cooled in an applied field and also cannot explain why the dielectric constant near 100 °K should decrease so rapidly above this temperature [11], a $1/T$ type variation being expected. Hence the possibility of some type of ordering process occurring near 100 °K is not excluded.

We did not observe the current reversal on warming probably because it was obscured by the second peak and the exponentially increasing current after this peak. This current is probably protonic in nature. Since positive ion states are always present in much smaller numbers than L-defects at the temperatures under consideration then their motion is the mechanism which limits the current. The activation energy measured should thus be just half the energy of formation of an ion from a HF molecule, since the activation energy for diffusion of an ion-state is zero, it being a quantum mechanical tunnelling process [28]. The measured activation energy of 0.34 ± 0.03 eV agrees very well with half the activation energy for release of an ion from HF which is estimated by Jaccard [28] to be 0.65 ± 0.01 eV.

Substituting our experimentally determined values for the polarization, P_∞ , in the Langevin-Debye equation yielded a dipole concentration of between 13% and 16% of the water molecule concentration. Calculation of the protonic current density at 140 °K for a sample containing 10^{23} m⁻³ HF, following Jaccard [28], gave a value of 2.7×10^{-5} A m⁻² whereas the experimentally determined value is 1.2×10^{-6} A m⁻², i.e. about 4% of the theoretical value. It may well be that the electric field in the crystal is substantially affected by space-charge shielding by protons. Potential probe measurements on pure polycrystalline ice samples at 203 °K by Cross [29] show the field in the crystal to be non-linear. Macdonald [30, 31] has calculated the theoretical potential distributions for a material containing mobile charge carriers of one sign only, which may combine with fixed charge centres of opposite sign. These curves show that the fields in the bulk of the material may be greatly reduced for blocking electrodes and since this is approximately the case in our measurements it may explain the low values of dipole concentration and current measured.

The function describing the depolarization current in the second type of experiment, assuming monomolecular kinetics are obeyed, has already been derived by Bucci *et al.* [23]. The depolarization current j is given by

$$j(T) = \frac{N \alpha \mu^2}{k T_p} [\tau_0 \exp(W/kT)]^{-1} \exp \left[- \int_0^T \{b \tau_0 \exp(W/kT')\}^{-1} dT' \right]. \quad (13)$$

This can be readily evaluated since the term

$$\exp \left[- \int \{b \tau_0 \exp(W/kT')\}^{-1} dT' \right]$$

can be seen to be similar to the integrating factor $R(T)$ for (8) and can be evaluated using (9). T_p is the temperature at which the polarization is "frozen-in" and depends upon the rate at which the sample is cooled in the applied field. This behaviour can be seen for different heating rates in Fig. 9. Fig. 10 shows a plot of (13) for two different heating rates.

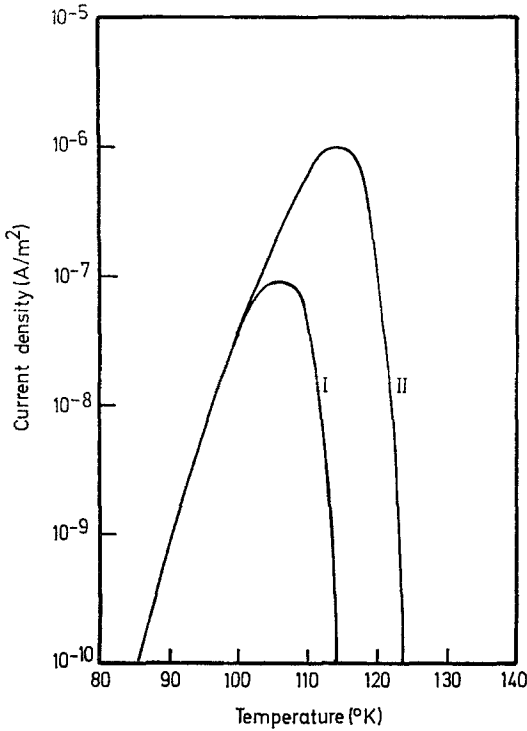

Fig. 10. Theoretical depolarization curves for a sample cooled in an applied field of 100 kV m^{-1} assuming $\tau_0 = 10^{-11} \text{ s}$. Curve I — depolarization current for $b = 0.12^\circ\text{K min}^{-1}$; Curve II — depolarization current for $b = 1.2^\circ\text{K min}^{-1}$

The observed current after the first peak did not decrease as rapidly as (13) predicts but this may have been due to a temperature gradient along the specimen broadening the peak, as mentioned before, or to interference by the mechanism producing the second peak. The area under the first peak gave a dipole concentration of about 16% of the water molecule concentration in good agreement with the first type of experiment. The value of the relaxation time τ at the current peak was found to be in the range 100–150 s, depending on the HF concentration, for both types of experiment.

Jaccard [28] has developed a theory to explain the observed dielectric behaviour of ice. He derived an expression for the relaxation time τ for orientation of the water molecules in terms of the contribution from each defect present in ice. The expression is

$$\frac{1}{\tau} = \frac{RkT}{e^2} \left[(\sigma^+ + \sigma^-) \frac{32}{3\sqrt{3}} \left(\frac{e}{e^\pm} \right)^2 + (\sigma^L + \sigma^D) \frac{3\sqrt{3}}{4} \left(\frac{2e}{eLD} \right)^2 \right] \quad (14)$$

where σ^i is the high frequency conductivity of species i and $\sigma^i = e^i n^i \mu^i$ where e^i is the effective charge transported by species i , n^i is the concentration of species i , μ^i is the mobility of species i , R is the oxygen - oxygen distance in the ice lattice and e is the electronic charge.

For HF doped ice the L defects and positive ion states are by far the majority defects and so (14) may be reduced to

$$\frac{1}{\tau} = \frac{RkT}{e^2} \left[\sigma^+ \frac{32}{3\sqrt{3}} \left(\frac{e}{e^+} \right)^2 + \sigma^L \frac{3\sqrt{3}}{4} \cdot \frac{4e^2}{(eL)^2} \right] = \frac{1}{\tau_+} + \frac{1}{\tau_L}. \quad (15)$$

Let us first calculate the temperature range over which the positive ion states could be expected to produce a dielectric relaxation peak. From (15) we see

$$\frac{1}{\tau_+} = \sigma^+ \frac{32}{3\sqrt{3}} \left(\frac{e}{e^+} \right)^2 \frac{RkT}{e^2}. \quad (16)$$

Now (16) is only strictly true if classical transfer of the positive ion states is considered. Since at 100 °K it is almost certainly a quantum mechanical tunnelling process, then (16) becomes [28]

$$\frac{1}{\tau_+} = \sigma^+ \frac{32}{3\sqrt{3}} \frac{R}{e^{+2}} \cdot \frac{1}{2} \Delta E_0 \coth \left(\frac{\Delta E_0}{2kT} \right), \quad (17)$$

where ΔE_0 is the energy difference between the two lowest levels in the potential well occupied by the proton. Using (17), values of τ_+ were calculated for HF concentrations of 10^{20} m^{-3} and 10^{25} m^{-3} , respectively. For HF concentration of 10^{20} m^{-3} τ_+ was found to be $3.8 \times 10^6 \text{ s}$ at 120 °K and $3.4 \times 10^2 \text{ s}$ at 130 °K. For HF concentration of 10^{25} m^{-3} τ_+ was found to be $1.2 \times 10^2 \text{ s}$ at 120 °K and 11 s at 130 °K. Hence we would expect the positive ion states to produce a dielectric relaxation peak near 120 °K for the highest HF concentrations used but for lower concentrations the peak would appear at higher temperatures. If the peak which occurs near 100 °K is due to dielectric relaxation then the L defects must be the mechanism controlling the relaxation time of the process. If this is the case then (15) becomes

$$\frac{1}{\tau} \simeq \frac{1}{\tau_L} = \frac{RkT}{e^2} \sigma^L \frac{3\sqrt{3}}{4} \cdot \frac{4e^2}{(eL)^2} = \frac{3\sqrt{3} RkT n^L \mu^L}{eL}. \quad (18)$$

Assuming the Einstein relation is obeyed i.e.

$$D^L = \frac{kT}{eL} \mu^L$$

then (18) becomes

$$\frac{1}{\tau} = 3\sqrt{3} R D^L n^L. \quad (19)$$

Now the L defects will be liberated from the HF molecules according to the law of mass action. Accordingly we can consider two cases:

(i) If the activation energy for release of an L defect from HF, W^L , is very much less than kT at the temperatures considered, then essentially the L defect concentration will equal the HF concentration and (19) will become

$$\tau = [3\sqrt{3} R D^L n_{\text{HF}}]^{-1} \quad (20)$$

where n_{HF} is the HF concentration.

Assuming $D^L = D_0^L \exp(-W_D^L/kT)$ then (20) can be expressed as

$$\tau = [3\sqrt{3} R D_0^L n_{\text{HF}}]^{-1} \exp(W_D^L/kT) = \tau_0 \exp(W/kT) \quad (21)$$

where $\tau_0 = \text{constant}/n_{\text{HF}}$ and $W = W_D^L = 0.235 \text{ eV}$, the activation energy for diffusion of L defects [28].

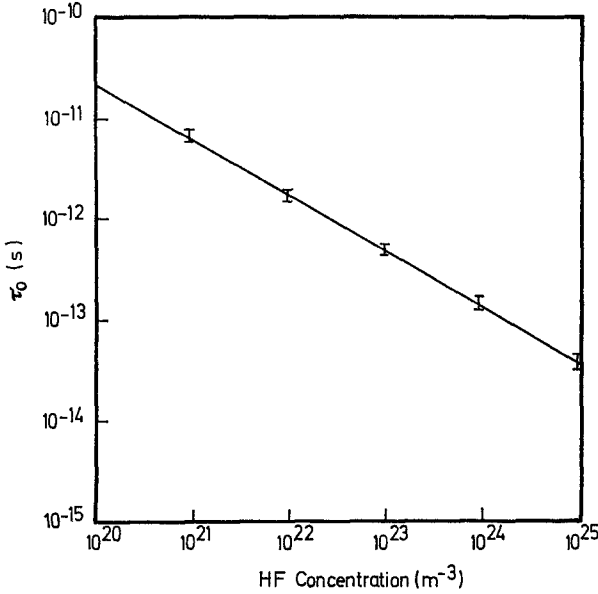

Fig. 11. τ_0 versus HF concentration for low temperature peak in HF doped ice samples

(ii) If $W^L \gtrsim kT$ then L defect concentration, n_L , will be given by

$$n_L^2 / (n_{HF} - n_L) = k^L = k_0^L \exp(-W^L / kT)$$

or approximately

$$n_L = (k^L n_{HF})^{1/2}$$

where k^L is the dissociation constant for liberation of L defects from HF. (19) then becomes

$$\tau = [3 \sqrt{3} R D_0^L (k_0^L n_{HF})^{1/2}]^{-1} \exp[(W_D^L + \frac{1}{2} W^L) / kT] = \tau'_0 \exp(W / kT)$$

where

$$\tau'_0 = \text{constant} / (n_{HF})^{1/2}$$

and

$$W' = W_D^L + \frac{1}{2} W^L = 0.235 + \frac{1}{2} W^L.$$

Now if we calculate τ_0 from our experimental curves and plot $\log \tau_0$ versus $\log n_{HF}$ we should obtain a straight line. If the slope is 1 then $W_L \ll kT$ and if the slope is 0.5 then $W_L \gtrsim kT$.

A plot of $\log \tau_0$ versus $\log n_{HF}$ is shown in Fig. 11. The slope is 0.54 ± 0.03 which rather clearly indicates that $W^L \gtrsim kT$. To estimate W^L we have

$$W' = 0.30 \pm 0.03 \text{ eV} = 0.235 + \frac{W^L}{2}$$

so

$$W^L = 0.12 \pm 0.06 \text{ eV}.$$

Substituting for D_0^L from Jaccard [28] we obtain a value for k_0^L of $6.3 \times 10^{28} \text{ m}^{-3}$. However it should be remembered that τ_0 and hence k_0^L are very sensitive functions of W . For $W = 0.27 \text{ eV}$, $k_0^L = 2 \times 10^{26} \text{ m}^{-3}$ and for $W = 0.33 \text{ eV}$, $k_0^L =$

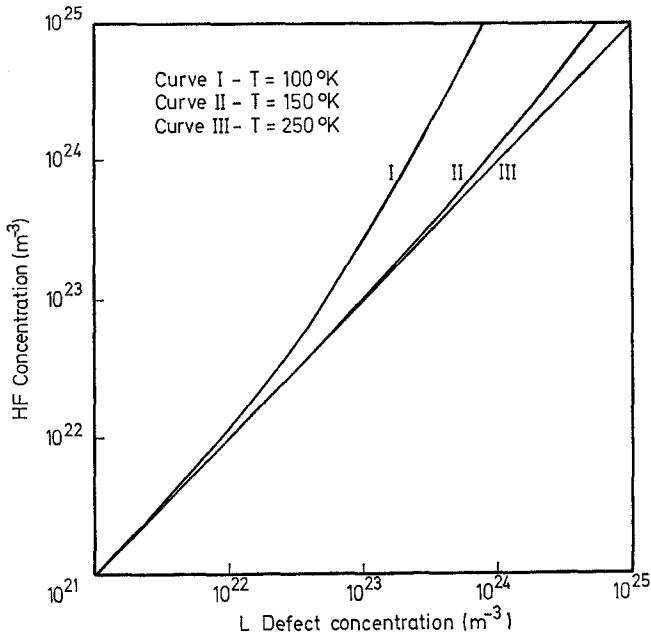

Fig. 12. HF concentration versus L defect concentration at various temperatures for HF doped ice samples

$3 \times 10^{32} \text{ m}^{-3}$ so before an accurate value of k_0^L can be found a much more accurate determination of W is needed.

Now Jaccard [28] has found that at a temperature of 219 °K the L defect concentration is essentially equal to the HF concentration. To check our results against his we calculated the L defect concentration using our values for k_0^L and W^L and the results are plotted in Fig. 12. For temperatures ≥ 200 °K each HF molecule essentially liberates an L defect in good agreement with Jaccard's result.

Our calculated values of k_0^L and W^L predict that the L defect concentration deviates from the square root dependence for HF concentrations $\leq 10^{22} \text{ m}^{-3}$ (see Fig. 12). This should be reflected in Fig. 11 by an increase in slope for HF concentrations $\leq 10^{22} \text{ m}^{-3}$. This increase in slope is not observed and it may well be that some modification of the theory at these temperatures is needed.

Conclusion

The current peak observed near 100 °K when HF doped ice is warmed in an applied field appears to be due to a dielectric relaxation process involving the orientation of water molecules in ice. This process occurs because HF releases sufficient L defects to reduce the relaxation time for orientation to the order of 100 s, which is necessary to observe such a peak. The L defects are liberated from the HF according to the law of mass action with an activation energy for liberation of $0.12 \pm 0.06 \text{ eV}$ and a dissociation constant $\sim 10^{29} \text{ m}^{-3}$.

The conclusion of Dengel *et al.* [11] that the current reversal phenomenon on warming constitutes ferroelectric behaviour appears dubious in view of our

theoretical predictions for a simple model of ice. However our model does not predict a current reversal on cooling nor can it explain the peak in dielectric constant observed by these authors and so the possibility of a ferroelectric ordering process near 100 °K cannot be ruled out.

If the peak at 100 °K is due to dielectric relaxation governed by the L defects then an alternative explanation must be sought for the peaks observed at higher temperatures. Since positive ion states are the only other major defect present in HF doped ice it may well be that the peak observed near 125 °K is due to their release from some type of trap, as has been suggested previously [16].

Acknowledgments. The authors wish to thank Dr. C. A. Sholl for many helpful discussions. This work is part of a program of study of partially disordered solids supported by the Australian Research Grants Committee.

References

1. Pauling, L.: *J. Amer. Chem. Soc.* **57**, 2680 (1935).
2. Giaouque, W. F., Stout, J. W.: *J. Amer. Chem. Soc.* **58**, 1144 (1936).
3. Bjerrum, N.: *K. danske. Vidensk. Selsk. mat.-fys. Medd.* **27**, (1), 3 (1951)
4. Pitzer, K. S., Polissar, J.: *J. phys. Chem.* **60**, 1140 (1956).
5. Rundle, R. E.: *J. chem. Phys.* **21**, 1311 (1953).
6. — *J. chem. Phys.* **22**, 344 (1954).
7. — *J. phys. Chem.* **59**, 680 (1955).
8. Peterson, S. W., Levy, H. A.: *Acta. cryst.* **10**, 70 (1957).
9. Whalley, E., Davidson, D. W., Heath, J. B. R.: *J. chem. Phys.* **45**, 3976 (1966).
10. — — *J. chem. Phys.* **48**, 2362 (1968).
11. Dengel, O., Eekener, U., Plitz, H., Riehl, N.: *Physics Letters* **9**, 291 (1964).
12. Van den Beukel, A.: *Phys. Status solidi* **28**, 565 (1968).
13. Pick, M. A.: *Physics of Ice, Proc. Int. Symp., Plenum Press N.Y. (1969)*, 344.
14. Helmreich, D.: *Physics of Ice, Proc. Int. Symp., Plenum Press N.Y. (1969)*, 231.
15. Bishop, P. G., Glen, J. W.: *Physics of Ice, Proc. Int. Symp., Plenum Press N.Y. (1969)*, 492.
16. Engelhardt, H., Riehl, N.: *Phys. kondens. Materie* **5**, 73 (1966).
17. — — Bullemer, B.: *Physics of Ice, Proc. Int. Symp., Plenum Press N.Y. (1969)*, 430.
18. Mascarenhas, S.: *Physics of Ice, Proc. Int. Symp., Plenum Press N.Y. (1969)*, 483.
19. Glockmann, H. P.: *Physics of Ice, Proc. Int. Symp., Plenum Press N.Y. (1969)*, 502.
20. Onsager, L.: *Ferroelectricity* (ed. E. F. Weller) Elsevier Amsterdam (1967), 16.
21. Kopp, M., Barnaal, D. E., Lowe, I. J.: *J. chem. Phys.* **43**, 2965 (1965).
22. Haltenorth, H., Klinger, J.: *Physics of Ice, Proc. Int. Symp., Plenum Press, N.Y. (1969)*, 579.
23. Bucci, C., Fieschi, R., Guidi, G.: *Phys. Rev.* **148**, 817 (1966).
24. Fröhlich, H.: *Theory of Dielectrics.* Oxford: Clarendon Press 1949.
25. Powles, J. G.: *J. chem. Phys.* **20**, 1302 (1952).
26. Auty, R. P., Cole, R. H.: *J. chem. Phys.* **20**, 1309 (1952).
27. Abramowitz, M., Stegun, I. A.: *Handbook of Mathematical Functions.* Dover N.Y. (1965), 231.
28. Jaccard, C.: *Helv. phys. Acta* **32**, 89 (1959).
29. Cross, J. D.: *Electrets. International Symposium* (Ed. Baxt and Perlman). The Electrochemical Society N.Y. (1968), 45.
30. Macdonald, J. R.: *J. chem. Phys.* **29**, 1346 (1958).
31. — *J. chem. Phys.* **30**, 806 (1959).

N. H. Fletcher
Department of Physics
University of New England
Armidale, N.S.W., 2351 Australia